

CATÁLOGO DE PEÇAS

ESTOFAMENTOS

ESTOFAMENTOS

MÓDULO MEIA CANA 25 X 12
COD - CM2512U

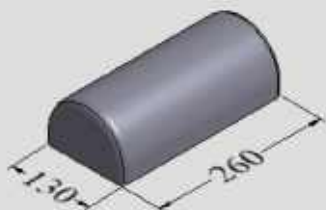

MÓDULO MEIA CANA 41 X 12
COD - CM4212U

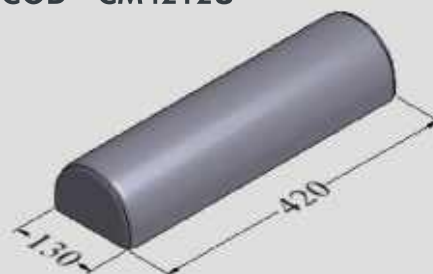

MÓDULO 2615 R
COD - CM2615R



MÓDULO 26 X 15 (PEQUENO) PU
COD - CM2615U

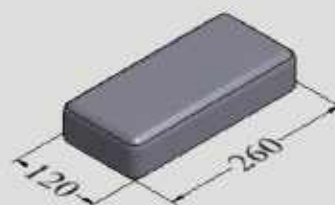

MÓDULO 26 X 26 (QUADRADO) PU
COD - CM2626U

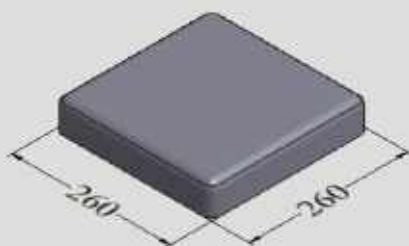

MÓDULO 3626U - BANCO PU
COD - CM3626U

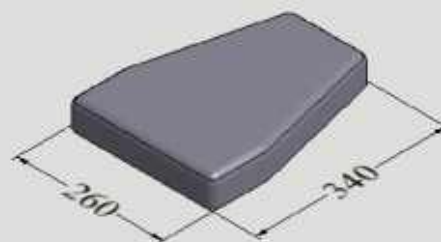

MÓDULO M3626 - BANCO REDONDO
COD - CM3626R



MÓDULO BANCO PARA BICICLETA
HORIZONTAL (BANCÃO) PU
COD - CM4134U

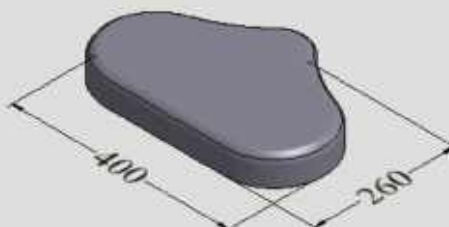

ESTOFAMENTOS

MÓDULO 40 X 40 ANATÔMICO ASSENTO
COD - CM4040RA

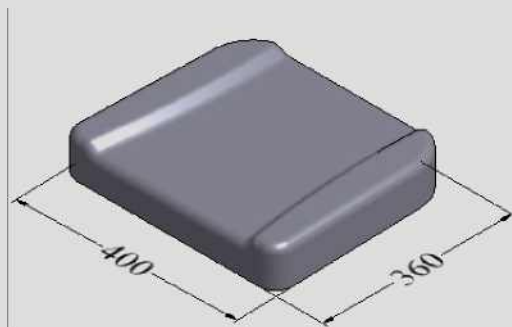

MÓDULO 41 X 33 (GRANDE) R
COD - CM4133R

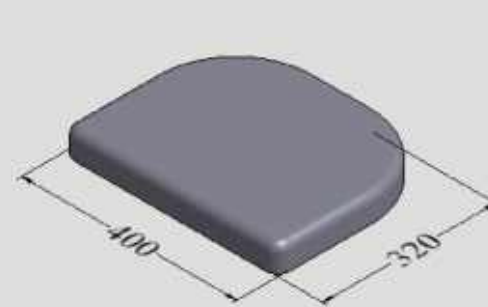

MÓDULO EXTENSOR-BR 3626U
COD - CM5846U

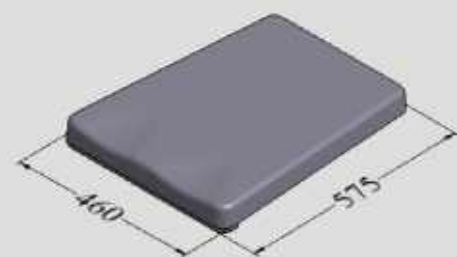

MÓDULO EXTENSOR CORTADO-BR
COD - CM4646U

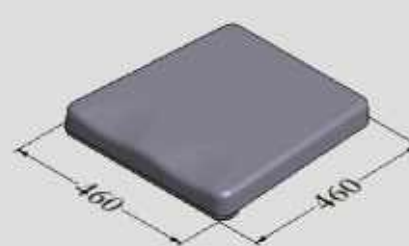

MÓDULO APOIO DE CABEÇA
COD - CMAC

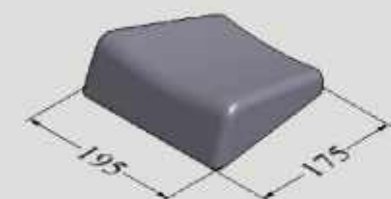

MÓDULO (MOD 20X20) RAIO10
COD - CMD

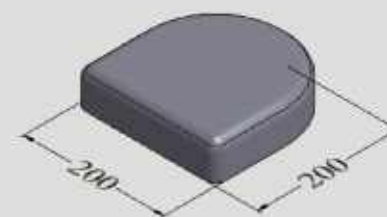

MÓDULO 41 X 33 (GRANDE) PU
COD - CM4133U

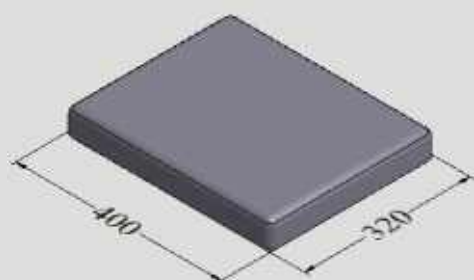

MÓDULO ROLINHO D 13 X 42
COD - CMROLG

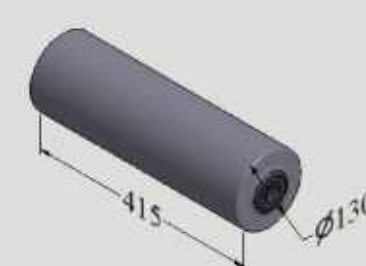

ESTOFAMENTOS

MÓDULO ROLINHO D 13 X 25
COD - CMROL25



MÓDULO ROLINHO D 13 X 17
COD - CMROLP



MÓDULO FLEXOR VETICAL
COD - CM 6026U

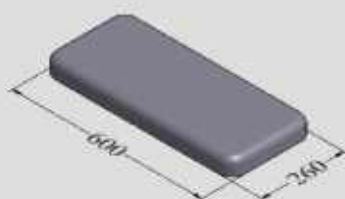

MÓDULO CAPELA
COD - CMCAPP



MÓDULO 60 X 40 ANATÔMICO ENCOSTO
COD - CM6040RA

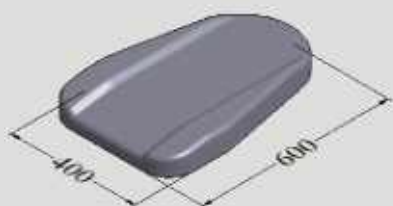

MÓDULO 6033R
COD - CM6033R



MÓDULO 80 X 26 (PRANCHA)
COD - CM8026R

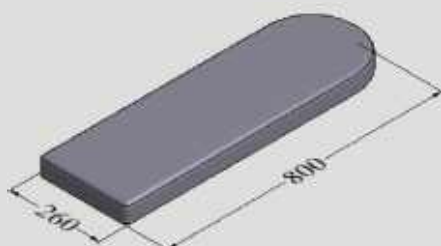

MÓDULO 80 X 26 PU
COD - CM8026U

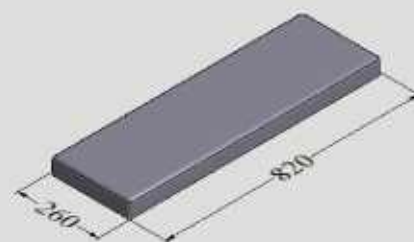

ESTOFAMENTOS

MÓDULO 80 X 33R
COD - CM8033R

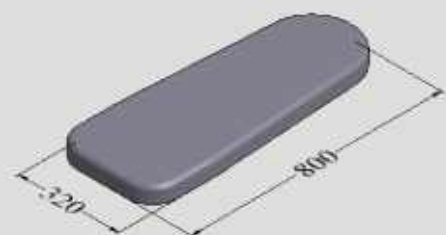

MÓDULO 120 X 26 PU
COD - CM12026U

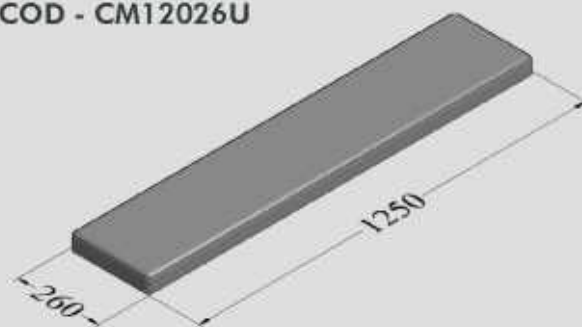

MÓDULO 120 X 26 (GRD)
COD - CM12026R

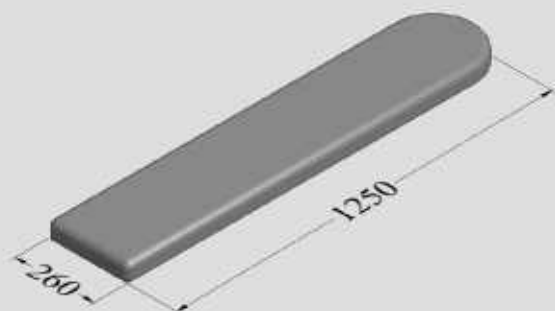

MÓDULO PRANCHA ABDOMINAL BR
COD - CM12041U

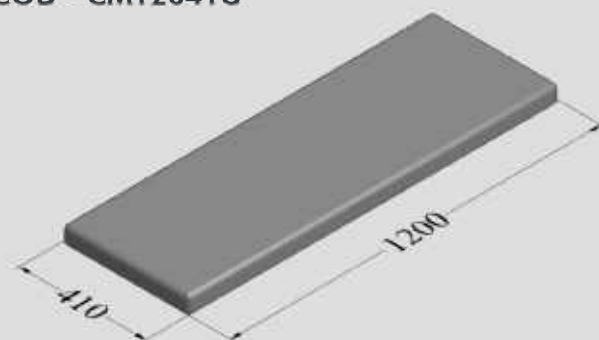

MÓDULO 41 X 26 MÉDIO
COD - CM 4126R

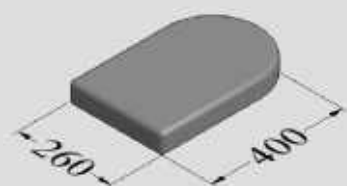

CAPAS DE PROTEÇÃO PARA ESTOFAMENTOS

MÓDULO ACABAMENTO D
(MOD 20X20) RAIOS 10E
COD - AMDE

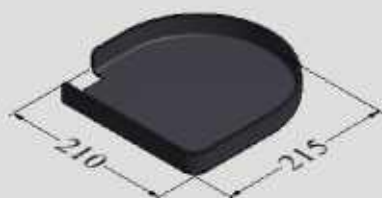

MÓDULO ACABAMENTO D
(MOD 20X20) RAIOS 10D
COD - AMDD

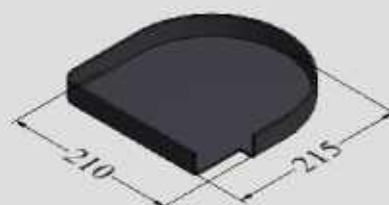

MÓDULO ACABAMENTO MEIA CANA
25 X 12 PU
COD - AM 2512U

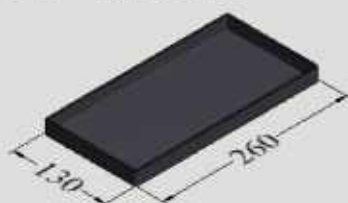

MÓDULO ACABAMENTO 26 X 15
(PEQUENO) REDONDO PU
COD - AM2615R



MÓDULO ACABAMENTO 26 X 15
(PEQUENO) PU
COD - AM2615U



MÓDULO ACABAMENTO 26 X 26
(QUADRADO) PU
COD - AM2626U

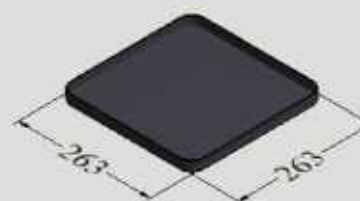

MÓDULO M3626 BANCO REDONDO
COD - AM3626R



MÓDULO M3626 BANCO
COD - AM3626U



CAPAS DE PROTEÇÃO PARA ESTOFAMENTOS

MÓDULO ACABAMENTO 40 X 40
ANATÔMICO ASSENTO (VC00160)

COD - AM4040RA

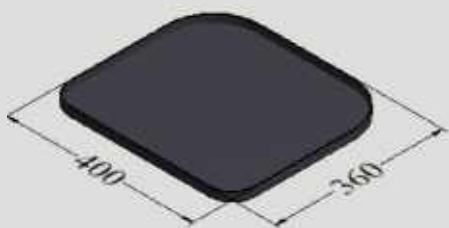

MÓDULO ACABAMENTO 41 X 26
(MED)

COD - AM4126R



MÓDULO ACABAMENTO 41 X 26
(MEDIO)PU

COD - AM 4126U

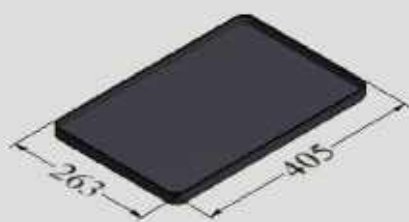

MÓDULO ACABAMENTO 41 X 33
(GRANDE)R

COD - AM 4133R

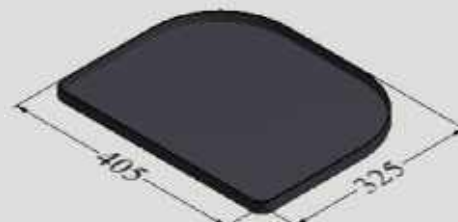

MÓDULO ACABAMENTO 41 X 33
(GRANDE)PU

COD - AM 4133U

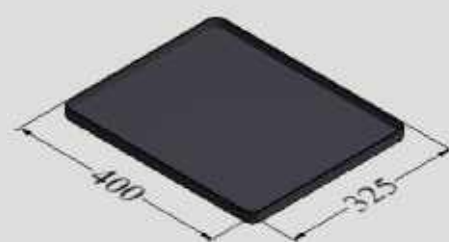

MÓDULO ACABAMENTO BANCO PARA
BICICLETA HORIZONTAL (BANCÃO) PU

COD - AM4134U



MÓDULO ACABAMENTO MEIA
CANA 42 X 12 PU

COD - AM 4212U

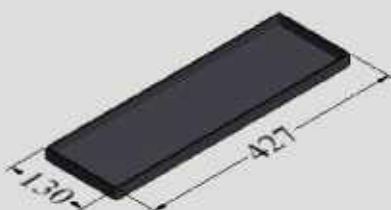

MÓDULO ACABAMENTO 60 X 33R

COD - AM 6033R

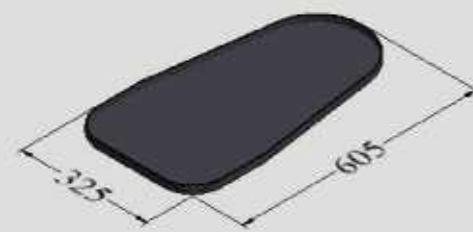

CAPAS DE PROTEÇÃO PARA ESTOFAMENTOS

MÓDULO ACABAMENTO 60 X 40
ANATÔMICO ENCOSTO (VC00150)

COD - AM 6040RA

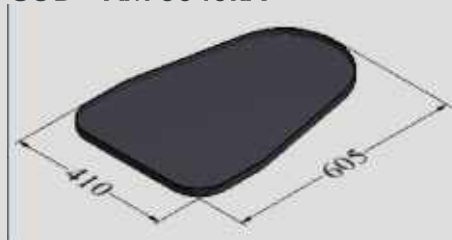

MÓDULO ACABAMENTO 80 X 26
(PRANCHA)PU

COD - AM8026U



MÓDULO ACABAMENTO 80 X 26
(PRANCHA)

COD - AM8026R

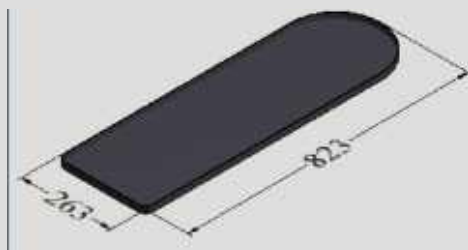

MÓDULO ACABAMENTO 30 X 33R

COD - AM8033R

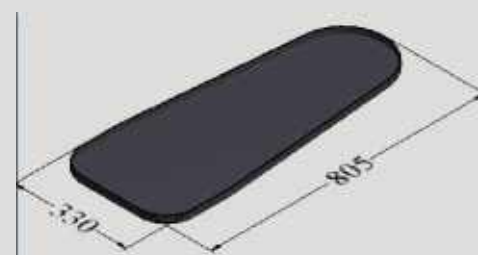

MÓDULO ACABAMENTO 120 X 26PU

COD - AM12026U

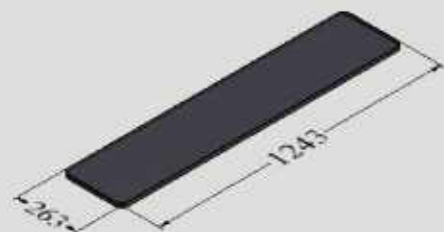

MÓDULO ACABAMENTO
120 X 26(GRD)

COD - AM12026R

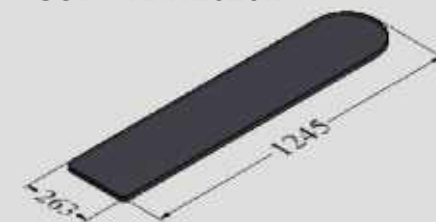

HASTE ACABAMENTO OB100

COD - AMOB100



HASTE ACABAMENTO OB150

COD - AMOB150



CAPAS DE PROTEÇÃO PARA ESTOFAMENTOS

MÓDULO ACABAMENTO
PROTETOR 56 X 13
COD - AM5613U



ACABAMENTO POLIA 3 mm
COD - IDS70

